

## MINI ONE POST

### E9B001- -

base number Color L9  
Temperature Finishes-06-08

- To build a product code in our configurator select the specify button on the base model # product page
- To build a manual product code on this datasheet choose from the options listed below in blue font and add the suffix to the base model #

#### GENERAL

Series: Mini One  
Brand: Platek  
Division: Exterior  
Mounting Type: Post  
Mounting Location: Above Ground  
Subcategory: Bollard - Mini

#### PHYSICAL

Shape: Rectangle  
Length (mm): 100  
Length (in): 3 <sup>15</sup>/<sub>16</sub>  
Width (mm): 100  
Width (in): 3 <sup>15</sup>/<sub>16</sub>  
Height (mm): 150  
Height (in): 5 <sup>7</sup>/<sub>8</sub>  
Light Distribution: Direct  
Diffuser: Transparent Flat Tempered Glass  
Fixture Finish: GRY / ANT  
Fixture Material: Aluminum Die Cast  
Upon Request: Finishes - Black, White, Bronze, Corten

#### ELECTRICAL

Lamp Type: LED  
Input Wattage (W): 7.3  
Total Output Wattage (W): 6  
Dimming: Non-Dimmable  
Driver Included: Yes  
Driver Location: Integrated  
Driver Type: Constant Current - 120Vac  
Driver Class: Class 2  
Input Voltage (V): 120 - 277  
Constant Current (mA): 500  
Upon Request: (Not included - see components [IP65 or higher enclosure to be supplied by others]): Remote: 0-10Vdc dimming / Phase dimming / Non-dimming 120/277Vac

#### LED

Color Temperature (°K): 2700 / 3000 / 4000  
Max. Delivered Lumen (lm): 95 / 100  
Nominal Lumen (lm): 780 / 810  
CRI: >90 CRI  
Lamp Life (hrs): 60000

#### OPTICAL

Optic°: 1 Opening

#### RATINGS AND CERTIFICATIONS

Certified By: Certified for North American Standards  
IP rating: IP65  
IK Rating: IK07  
Bug Rating: B0 U0 G0  
Upon Request: Higher Maximum Ambient Temperature

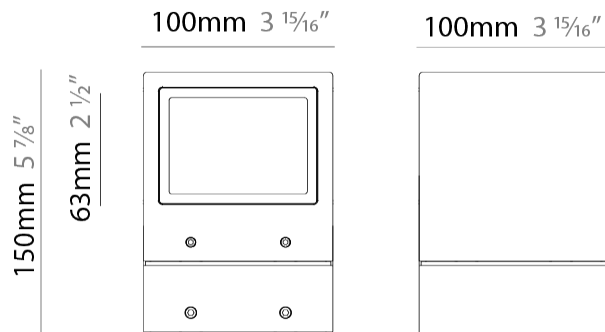

## MINI ONE POST

E9B001-

PROJECT

TYPE

SPECIFIER

QUANTITY

DATE



## MINI ONE POST

**E9B002-** \_\_\_\_\_ - \_\_\_\_\_  
 base number Color L9  
 Temperature Finishes-06-08

- To build a product code in our configurator select the specify button on the base model # product page
- To build a manual product code on this datasheet choose from the options listed below in blue font and add the suffix to the base model #

### GENERAL

Series: Mini One  
 Brand: Platek  
 Division: Exterior  
 Mounting Type: Post  
 Mounting Location: Above Ground  
 Subcategory: Bollard - Mini

### PHYSICAL

Shape: Rectangle  
 Length (mm): 100  
 Length (in): 3 <sup>15</sup>/<sub>16</sub>  
 Width (mm): 100  
 Width (in): 3 <sup>15</sup>/<sub>16</sub>  
 Height (mm): 150  
 Height (in): 5 <sup>7</sup>/<sub>8</sub>  
 Light Distribution: Direct  
 Diffuser: Transparent Flat Tempered Glass  
 Fixture Finish: GRY / ANT  
 Fixture Material: Aluminum Die Cast  
 Upon Request: Finishes - Black, White, Bronze, Corten

### ELECTRICAL

Lamp Type: LED  
 Input Wattage (W): 7.3  
 Total Output Wattage (W): 6  
 Dimming: Non-Dimmable  
 Driver Included: Yes  
 Driver Location: Integrated  
 Driver Type: Constant Current - 120Vac  
 Driver Class: Class 2  
 Input Voltage (V): 120 - 277  
 Constant Current (mA): 500  
 Upon Request: (Not included - see components [IP65 or higher enclosure to be supplied by others]): Remote: 0-10Vdc dimming / Phase dimming / Non-dimming 120/277Vac

### LED

Color Temperature (°K): 2700 / 3000 / 4000  
 Max. Delivered Lumen (lm): 195 / 205  
 Nominal Lumen (lm): 780 / 810  
 CRI: >80 CRI  
 Lamp Life (hrs): 60000

### OPTICAL

Optic°: 2 Openings

### RATINGS AND CERTIFICATIONS

Certified By: Certified for North American Standards  
 IP rating: IP65  
 IK Rating: IK07  
 Bug Rating: B0 U0 G0  
 Upon Request: Higher Maximum Ambient Temperature

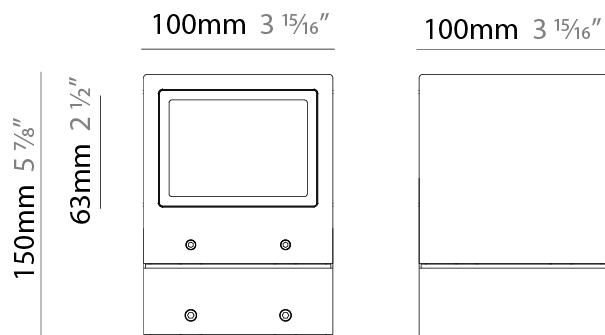

## MINI ONE POST

E9B002-

PROJECT

TYPE

SPECIFIER

QUANTITY

DATE



PROJECT	_____
TYPE	_____
SPECIFIER	_____
QUANTITY	_____
DATE	_____

## MINI ONE POST

**E9B004-** \_\_\_\_\_ - \_\_\_\_\_  
 base number    Color    L9  
                          Temperature    Finishes-06-08

- To build a product code in our configurator select the specify button on the base model # product page
- To build a manual product code on this datasheet choose from the options listed below in blue font and add the suffix to the base model #

### GENERAL

Series: Mini One  
 Brand: Platek  
 Division: Exterior  
 Mounting Type: Post  
 Mounting Location: Above Ground  
 Subcategory: Bollard - Mini

### PHYSICAL

Shape: Rectangle  
 Length (mm): 100  
 Length (in): 3 <sup>15</sup>/<sub>16</sub>  
 Width (mm): 100  
 Width (in): 3 <sup>15</sup>/<sub>16</sub>  
 Height (mm): 150  
 Height (in): 5 <sup>7</sup>/<sub>8</sub>  
 Light Distribution: Direct  
 Diffuser: Transparent Flat Tempered Glass  
 Fixture Finish: GRY / ANT  
 Fixture Material: Aluminum Die Cast  
 Upon Request: Finishes - Black, White, Bronze, Corten

### ELECTRICAL

Lamp Type: LED  
 Input Wattage (W): 7.3  
 Total Output Wattage (W): 6  
 Dimming: Non-Dimmable  
 Driver Included: Yes  
 Driver Location: Integrated  
 Driver Type: Constant Current - 120Vac  
 Driver Class: Class 2  
 Input Voltage (V): 120 - 277  
 Constant Current (MA): 500  
 Upon Request: (Not included - see components [IP65 or higher enclosure to be supplied by others]): Remote: 0-10Vdc dimming / Phase dimming / Non-dimming 120/277Vac

### LED

Color Temperature (°K): 2700 / 3000 / 4000  
 Max. Delivered Lumen (lm): 415 / 430  
 Nominal Lumen (lm): 780 / 810  
 CRI: >90 CRI  
 Lamp Life (hrs): 60000

### OPTICAL

Optic°: 4 Openings

### RATINGS AND CERTIFICATIONS

Certified By: Certified for North American Standards  
 IP rating: IP65  
 IK Rating: IK07  
 Bug Rating: B0 U0 G0  
 Upon Request: Higher Maximum Ambient Temperature



## MINI ONE POST

E9B004-

PROJECT

TYPE

SPECIFIER

QUANTITY

DATE



PROJECT
TYPE
SPECIFIER
QUANTITY
DATE

## MINI ONE POST

**E9B008-** -  
 base number    Color    L9  
                          Temperature    Finishes-06-08

- To build a product code in our configurator select the specify button on the base model # product page
- To build a manual product code on this datasheet choose from the options listed below in blue font and add the suffix to the base model #

### GENERAL

Series: Mini One  
 Brand: Platek  
 Division: Exterior  
 Mounting Type: Post  
 Mounting Location: Above Ground  
 Subcategory: Bollard

### PHYSICAL

Shape: Rectangle  
 Length (mm): 100  
 Length (in): 3 <sup>15</sup>/<sub>16</sub>  
 Width (mm): 100  
 Width (in): 3 <sup>15</sup>/<sub>16</sub>  
 Height (mm): 500  
 Height (in): 19 <sup>11</sup>/<sub>16</sub>  
 Light Distribution: Direct  
 Diffuser: Transparent Flat Tempered Glass  
 Fixture Finish: GRY / ANT  
 Fixture Material: Aluminum Die Cast  
 Upon Request: Finishes - Black, White, Bronze, Corten

### ELECTRICAL

Lamp Type: LED  
 Input Wattage (W): 9.5  
 Total Output Wattage (W): 9  
 Dimming: Non-Dimmable  
 Driver Included: Yes  
 Driver Location: Integrated  
 Driver Type: Constant Current - 120Vac  
 Driver Class: Class 2  
 Input Voltage (V): 120 - 277  
 Constant Current (mA): 700  
 Upon Request: (Not included - see components [IP65 or higher enclosure to be supplied by others]): Remote: 0-10Vdc dimming / Phase dimming / Non-dimming 120/277Vac

### LED

Color Temperature (°K): 2700 / 3000 / 4000  
 Max. Delivered Lumen (lm): 110 / 115  
 Nominal Lumen (lm): 1040 / 1080  
 CRI: >80 CRI  
 Lamp Life (hrs): 60000

### OPTICAL

Optic°: 1 Opening

### RATINGS AND CERTIFICATIONS

Certified By: Certified for North American Standards  
 IP rating: IP65  
 IK Rating: IK07  
 Bug Rating: B0 U0 G0  
 Upon Request: Higher Maximum Ambient Temperature

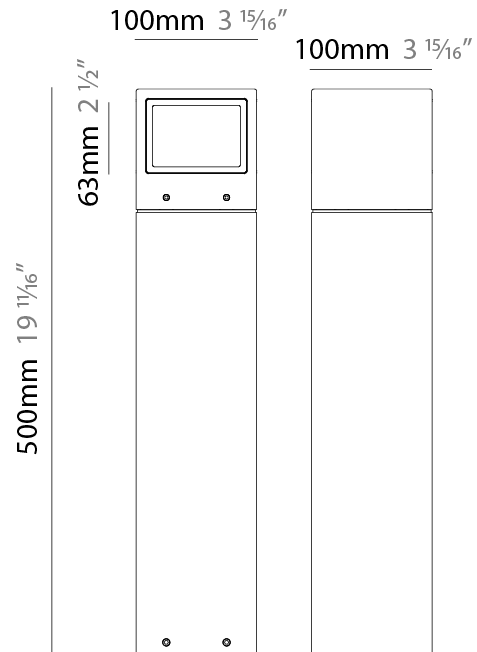

## MINI ONE POST

E9B008-

PROJECT

TYPE

SPECIFIER

QUANTITY

DATE

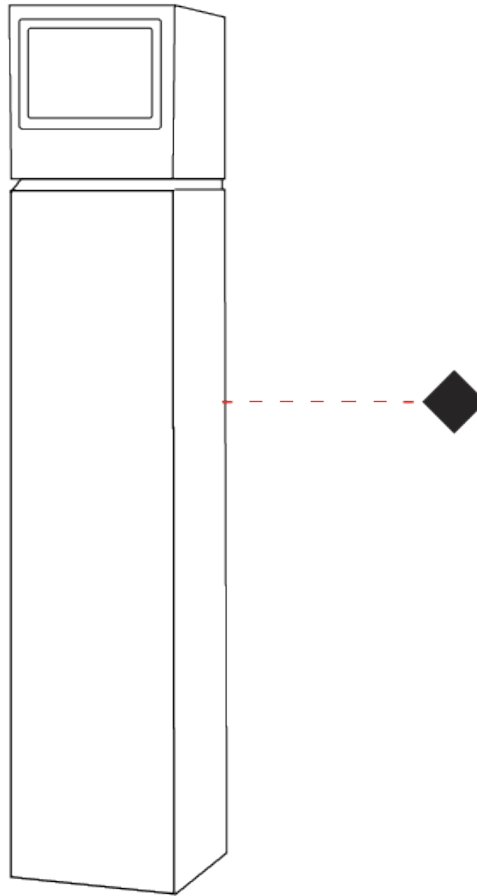



## MINI ONE POST

### E9B009-

base number Color L9  
Temperature Finishes-06-08

- To build a product code in our configurator select the specify button on the base model # product page
- To build a manual product code on this datasheet choose from the options listed below in blue font and add the suffix to the base model #

#### GENERAL

Series: Mini One  
Brand: Platek  
Division: Exterior  
Mounting Type: Post  
Mounting Location: Above Ground  
Subcategory: Bollard

#### PHYSICAL

Shape: Rectangle  
Length (mm): 100  
Length (in): 3 <sup>15</sup>/<sub>16</sub>  
Width (mm): 100  
Width (in): 3 <sup>15</sup>/<sub>16</sub>  
Height (mm): 500  
Height (in): 19 <sup>11</sup>/<sub>16</sub>  
Light Distribution: Direct  
Diffuser: Transparent Flat Tempered Glass  
Fixture Finish: GRY / ANT  
Fixture Material: Aluminum Die Cast  
Upon Request: Finishes - Black, White, Bronze, Corten

#### ELECTRICAL

Lamp Type: LED  
Input Wattage (W): 9.5  
Total Output Wattage (W): 8  
Dimming: Non-Dimmable  
Driver Included: Yes  
Driver Location: Integrated  
Driver Type: Constant Current - 120Vac  
Driver Class: Class 2  
Input Voltage (V): 120 - 277  
Constant Current (mA): 700  
Upon Request: (Not included - see components [IP65 or higher enclosure to be supplied by others]): Remote: 0-10Vdc dimming / Phase dimming / Non-dimming 120/277Vac

#### LED

Color Temperature (°K): 2700 / 3000 / 4000  
Max. Delivered Lumen (lm): 230 / 240  
Nominal Lumen (lm): 1040 / 1080  
CRI: >80 CRI  
Lamp Life (hrs): 60000

#### OPTICAL

Optic°: 2 Openings

#### RATINGS AND CERTIFICATIONS

Certified By: Certified for North American Standards  
IP rating: IP65  
IK Rating: IK07  
Bug Rating: B0 U0 G0  
Upon Request: Higher Maximum Ambient Temperature

PROJECT
TYPE
SPECIFIER
QUANTITY
DATE

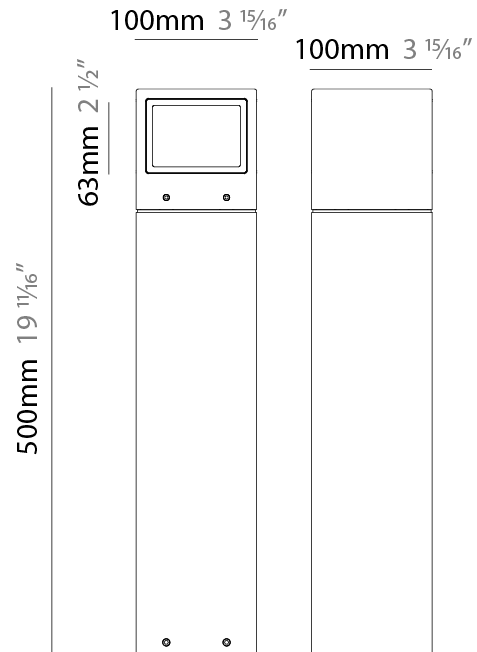

## MINI ONE POST

E9B009-

PROJECT \_\_\_\_\_

TYPE \_\_\_\_\_

SPECIFIER \_\_\_\_\_

QUANTITY \_\_\_\_\_

DATE \_\_\_\_\_

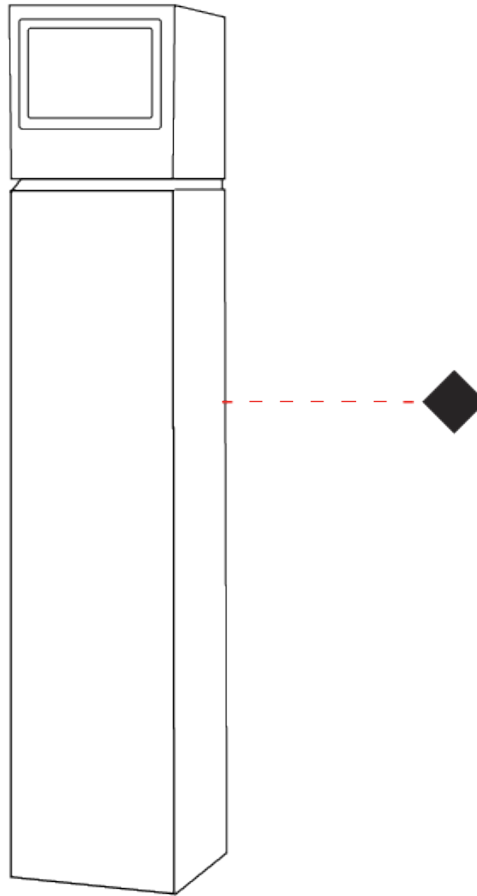

E

## MINI ONE POST

### E9B010-

base number    Color    L9  
 Temperature    Finishes-06-08

- To build a product code in our configurator select the specify button on the base model # product page
- To build a manual product code on this datasheet choose from the options listed below in blue font and add the suffix to the base model #

#### GENERAL

Series: Mini One  
 Brand: Platek  
 Division: Exterior  
 Mounting Type: Post  
 Mounting Location: Above Ground  
 Subcategory: Bollard

#### PHYSICAL

Shape: Rectangle  
 Length (mm): 100  
 Length (in): 3 <sup>15</sup>/<sub>16</sub>  
 Width (mm): 100  
 Width (in): 3 <sup>15</sup>/<sub>16</sub>  
 Height (mm): 500  
 Height (in): 19 <sup>11</sup>/<sub>16</sub>  
 Light Distribution: Direct  
 Diffuser: Transparent Flat Tempered Glass  
 Fixture Finish: GRY / ANT  
 Fixture Material: Aluminum Die Cast  
 Upon Request: Finishes - Black, White, Bronze, Corten

#### ELECTRICAL

Lamp Type: LED  
 Input Wattage (W): 9.5  
 Total Output Wattage (W): 8  
 Dimming: Non-Dimmable  
 Driver Included: Yes  
 Driver Location: Integrated  
 Driver Type: Constant Current - 120Vac  
 Driver Class: Class 2  
 Input Voltage (V): 120 - 277  
 Constant Current (mA): 700  
 Upon Request: (Not included - see components [IP65 or higher enclosure to be supplied by others]): Remote: 0-10Vdc dimming / Phase dimming / Non-dimming 120/277Vac

#### LED

Color Temperature (°K): 2700 / 3000 / 4000  
 Max. Delivered Lumen (lm): 490 / 510  
 Nominal Lumen (lm): 1040 / 1080  
 CRI: >80 CRI  
 Lamp Life (hrs): 60000

#### OPTICAL

Optic°: 4 Openings

#### RATINGS AND CERTIFICATIONS

Certified By: Certified for North American Standards  
 IP rating: IP65  
 IK Rating: IK07  
 Bug Rating: B0 U0 G0  
 Upon Request: Higher Maximum Ambient Temperature

PROJECT
TYPE
SPECIFIER
QUANTITY
DATE

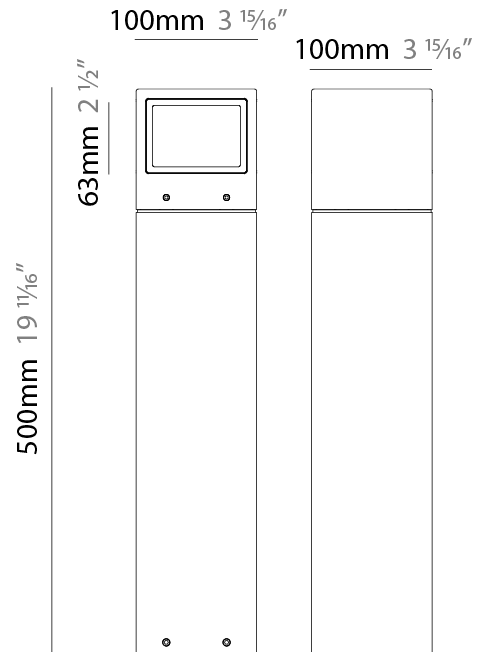

## MINI ONE POST

E9B010-

PROJECT

TYPE

SPECIFIER

QUANTITY

DATE

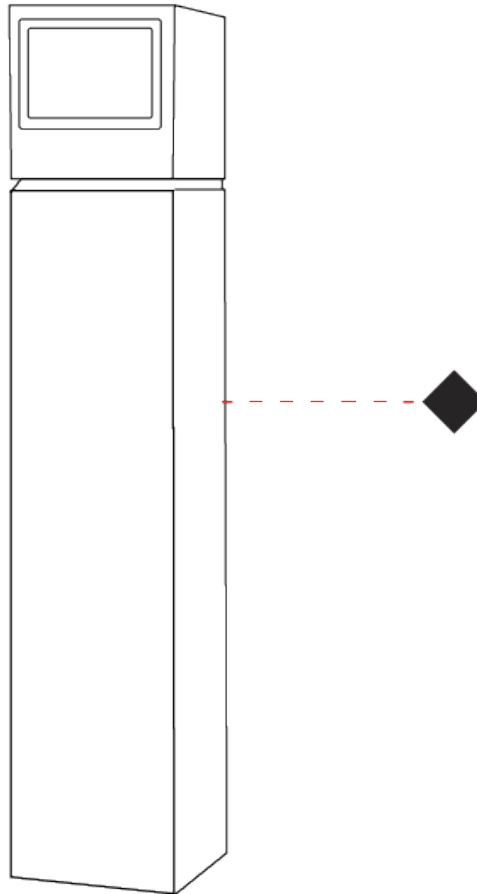

E

## MINI ONE POST

### E9B246-

base number    Color    L9  
 Temperature    Finishes-06-08

- To build a product code in our configurator select the specify button on the base model # product page
- To build a manual product code on this datasheet choose from the options listed below in blue font and add the suffix to the base model #

#### GENERAL

Series: Mini One  
 Brand: Platek  
 Division: Exterior  
 Mounting Type: Post  
 Mounting Location: Above Ground  
 Subcategory: Bollard

#### PHYSICAL

Shape: Rectangle  
 Length (mm): 100  
 Length (in): 3 <sup>15</sup>/<sub>16</sub>  
 Width (mm): 100  
 Width (in): 3 <sup>15</sup>/<sub>16</sub>  
 Height (mm): 800  
 Height (in): 31 <sup>1</sup>/<sub>2</sub>  
 Light Distribution: Direct  
 Diffuser: Transparent Flat Tempered Glass  
 Fixture Finish: GRY / ANT  
 Fixture Material: Aluminum Die Cast  
 Upon Request: Finishes - Black, White, Bronze, Corten

#### ELECTRICAL

Lamp Type: LED  
 Input Wattage (W): 10.5  
 Total Output Wattage (W): 9  
 Dimming: Non-Dimmable  
 Driver Included: Yes  
 Driver Location: Integrated  
 Driver Type: Constant Current - 120Vac  
 Driver Class: Class 2  
 Input Voltage (V): 120  
 Constant Current (MA): 700

#### LED

Color Temperature (°K): 2700 / 3000 / 4000  
 Max. Delivered Lumen (lm): 110 / 115  
 Nominal Lumen (lm): 1040 / 1080  
 CRI: >80 CRI  
 Lamp Life (hrs): 60000

#### OPTICAL

Optic°: 1 Opening

#### RATINGS AND CERTIFICATIONS

Certified By: Certified for North American Standards  
 IP rating: IP65  
 IK Rating: IK07  
 Bug Rating: B0 U0 G0  
 Upon Request: Higher Maximum Ambient Temperature

PROJECT
TYPE
SPECIFIER
QUANTITY
DATE

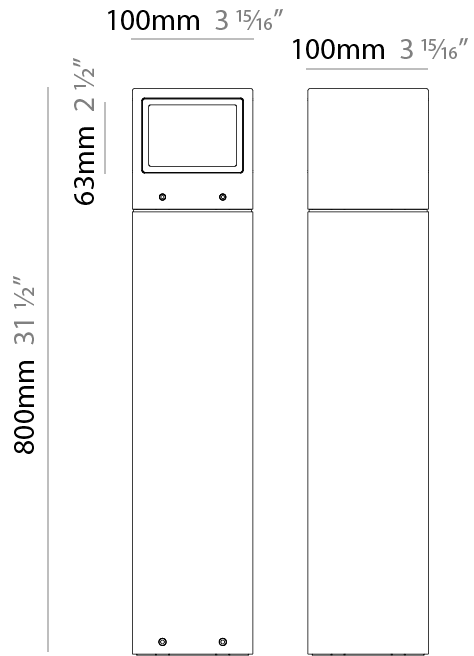

## MINI ONE POST

E9B246-

PROJECT

TYPE

SPECIFIER

QUANTITY

DATE

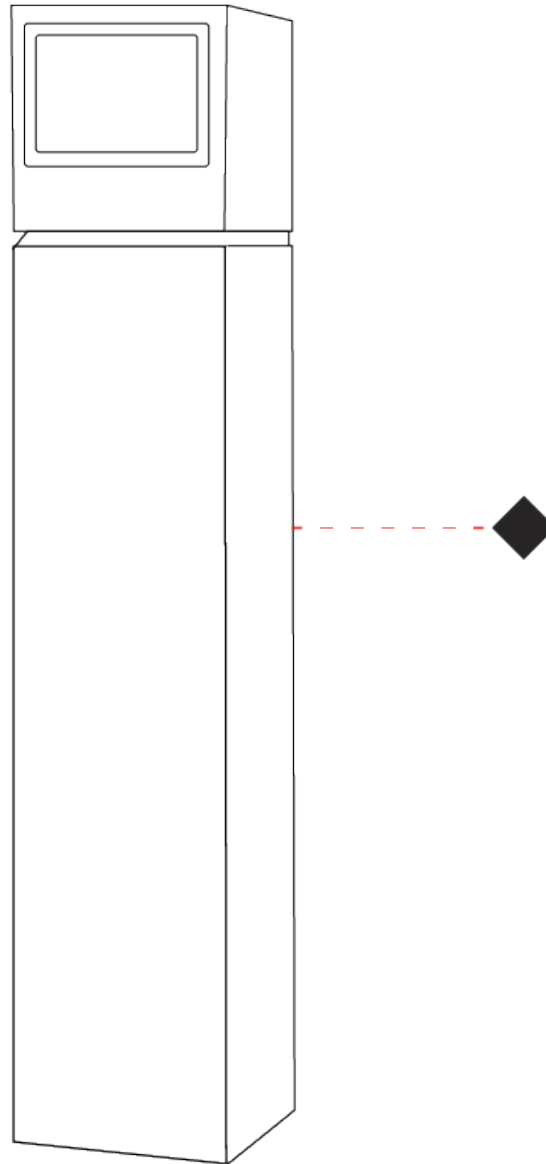

E

PROJECT
TYPE
SPECIFIER
QUANTITY
DATE

## MINI ONE POST

**E9B247-** -  
 base number    Color    L9  
                          Temperature    Finishes-06-08

- To build a product code in our configurator select the specify button on the base model # product page
- To build a manual product code on this datasheet choose from the options listed below in blue font and add the suffix to the base model #

### GENERAL

Series: Mini One  
 Brand: Platek  
 Division: Exterior  
 Mounting Type: Post  
 Mounting Location: Above Ground  
 Subcategory: Bollard

### PHYSICAL

Shape: Rectangle  
 Length (mm): 100  
 Length (in): 3 15/16  
 Width (mm): 100  
 Width (in): 3 15/16  
 Height (mm): 800  
 Height (in): 31 1/2  
 Light Distribution: Direct  
 Diffuser: Transparent Flat Tempered Glass  
 Fixture Finish: GRY / ANT  
 Fixture Material: Aluminum Die Cast  
 Upon Request: Finishes - Black, White, Bronze, Corten

### ELECTRICAL

Lamp Type: LED  
 Input Wattage (W): 10.5  
 Total Output Wattage (W): 9  
 Dimming: Non-Dimmable  
 Driver Included: Yes  
 Driver Location: Integrated  
 Driver Type: Constant Current - 120Vac  
 Driver Class: Class 2  
 Input Voltage (V): 120  
 Constant Current (MA): 700

### LED

Color Temperature (°K): 2700 / 3000 / 4000  
 Max. Delivered Lumen (lm): 230 / 240  
 Nominal Lumen (lm): 1040 / 1080  
 CRI: >80 CRI  
 Lamp Life (hrs): 60000

### OPTICAL

Optic°: 2 Openings

### RATINGS AND CERTIFICATIONS

Certified By: Certified for North American Standards  
 IP rating: IP65  
 IK Rating: IK07  
 Bug Rating: B0 U0 G0  
 Upon Request: Higher Maximum Ambient Temperature

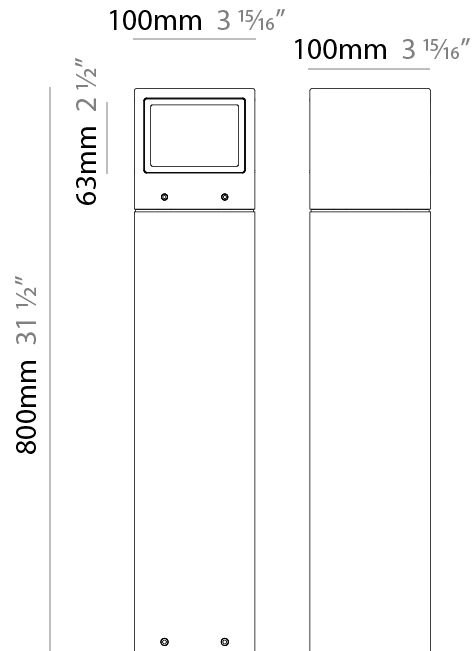

## MINI ONE POST

E9B247-

PROJECT

TYPE

SPECIFIER

QUANTITY

DATE

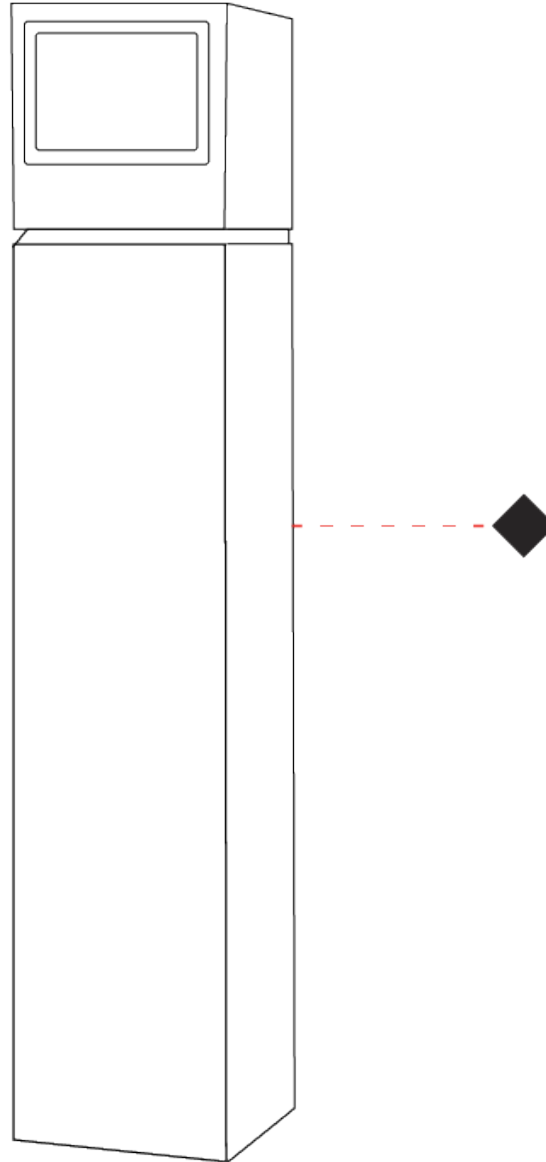

E



PROJECT
TYPE
SPECIFIER
QUANTITY
DATE

## MINI ONE POST

**E9B248-** -  
 base number    Color    L9  
                          Temperature    Finishes-06-08

- To build a product code in our configurator select the specify button on the base model # product page
- To build a manual product code on this datasheet choose from the options listed below in blue font and add the suffix to the base model #

### GENERAL

Series: Mini One  
 Brand: Platek  
 Division: Exterior  
 Mounting Type: Post  
 Mounting Location: Above Ground  
 Subcategory: Bollard

### PHYSICAL

Shape: Rectangle  
 Length (mm): 100  
 Length (in): 3 15/16  
 Width (mm): 100  
 Width (in): 3 15/16  
 Height (mm): 800  
 Height (in): 31 1/2  
 Light Distribution: Direct  
 Diffuser: Transparent Flat Tempered Glass  
 Fixture Finish: GRY / ANT  
 Fixture Material: Aluminum Die Cast  
 Upon Request: Finishes - Black, White, Bronze, Corten

### ELECTRICAL

Lamp Type: LED  
 Input Wattage (W): 10.5  
 Total Output Wattage (W): 9  
 Dimming: Non-Dimmable  
 Driver Included: Yes  
 Driver Location: Integrated  
 Driver Type: Constant Current - 120Vac  
 Driver Class: Class 2  
 Input Voltage (V): 120  
 Constant Current (MA): 700

### LED

Color Temperature (°K): 2700 / 3000 / 4000  
 Max. Delivered Lumen (lm): 490 / 510  
 Nominal Lumen (lm): 1040 / 1080  
 CRI: >80 CRI  
 Lamp Life (hrs): 60000

### OPTICAL

Optic°: 4 Openings

### RATINGS AND CERTIFICATIONS

Certified By: Certified for North American Standards  
 IP rating: IP65  
 IK Rating: IK07  
 Bug Rating: B0 U0 G0  
 Upon Request: Higher Maximum Ambient Temperature

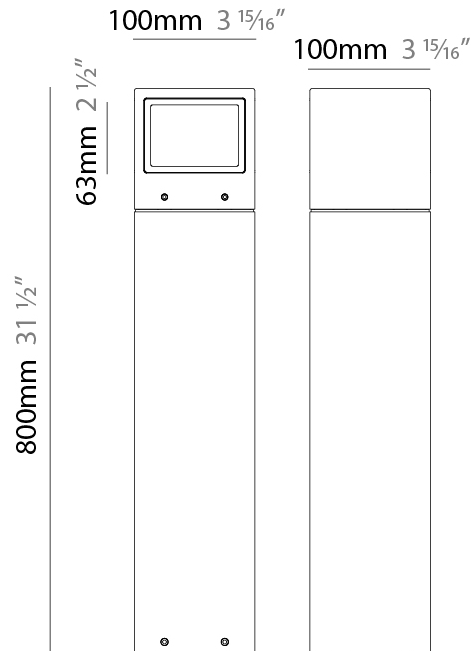

## MINI ONE POST

E9B248-

PROJECT

TYPE

SPECIFIER

QUANTITY

DATE

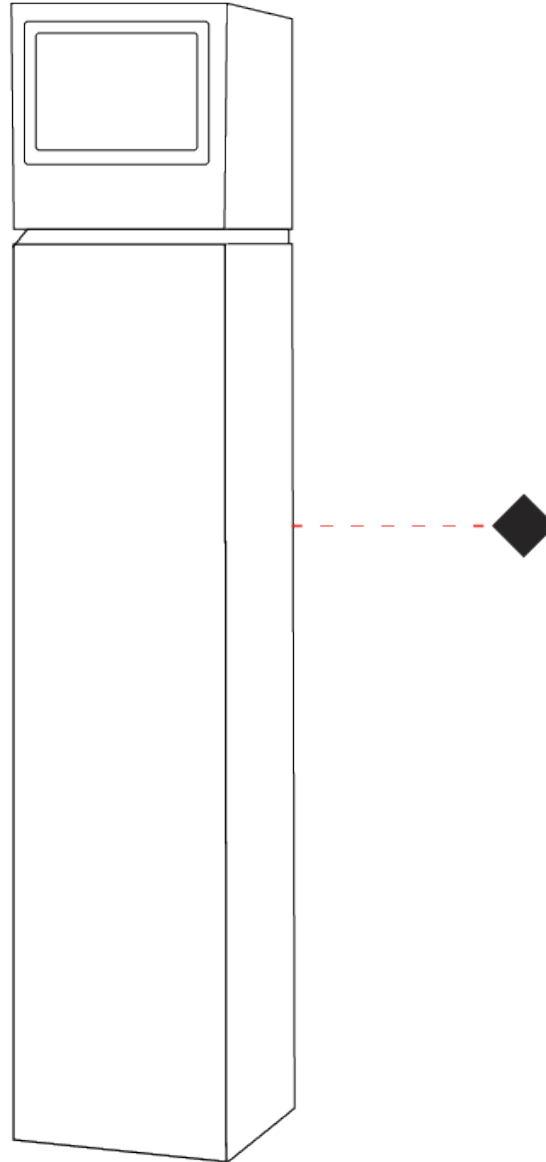

E

## MINI ONE COLOR FINISH CHART

PROJECT

TYPE

SPECIFIER

QUANTITY

DATE

### Fixture Finish

Gray - GRY

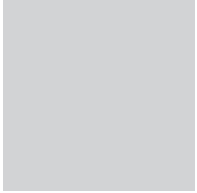

Anthracite - ANT



**Digital:** Not all screens are calibrated the same, and therefore, colors will appear differently between screens.

**Physical:** When texture is involved, there will be variations in color, character and tone within a product series and between product families.



### LEGEND

	floor-mounted		pivotal		special LED (upon request) RGB, RGBW, tunable, gold+, meat+, art+, fashion+
	wall and ceiling: recessed and surface mounted		rotating		warm dim / natural dimming LED
	ceiling-mounted and wall-mounted		illuminate tilted		rechargeable battery powered
	wall-mounted		color of suspension cable		fixture with natural vivid LED (upon request)
	omni-directional light distribution		length of suspension cable		color rendering index
	direct light distribution		reflector degree selection		color temperature
	direct/indirect light distribution		super spot		lumen (luminous flux)
	indirect light distribution		lens		efficacy (lumens per watt)
	asymmetric light distribution		lens pack		Unified Glare Rating (UGR) range from 5-40
	aura light distribution		shine ring		marine grade (AISI 316 stainless steel)
	round wall or ceiling cut-out		integrated shine ring with diffuser		walk on
	square wall or ceiling cut-out		free individual colors 01-29		drive on
	the supplied jig specifies the cutout dimensions		individual colors: 00 (free of charge), 01-25 (extra charge)		Dark Sky Compliance
	minimum distance (meters) lamp - object		luminaire part to be colored (F1)		Americans with Disabilities Act (less than 4" off the wall located between 27"-84" from floor)
	recessed depth		luminaire part to be colored (F2)		lamp protected against explosion
	ceiling thickness in mm		luminaire part to be colored (F3)		blown glass using traditional methods by master glass blower
	ceiling thickness selection		luminaire part to be colored (F4)		acoustic material
	dimnable DP (phase), DV (0-10V), DD (dali), DS (step-dim)		luminaire part to be colored (F5)		protection class I, protection insulation
	included or excluded LED driver/transformer/control gear		color of 3-circuit adaptor		protection class II, protection insulation
	separately switchable		indirect diffuser		ETL Certified to UL and CSA Standards
	sensor		direct diffuser		UL Certified to UL and CSA Standards
	remote control		ball-proof (upon request)		CSA Certified to UL and CSA Standards
	available upon request		accessory		Certified for North American Standards

### IP RATING

	protected against ingress of solid bodies greater than 12.5mm (finger)
	protected against ingress of solid bodies greater than 2.5mm protected against sprays of water up to 60 degrees from the vertical (rain)
	protected against ingress of solid bodies greater than 1mm (wire) no protection against the ingress of moisture
	protected against ingress of solid bodies greater than 1mm (wire) protected against sprays of water up to 60 degrees from the vertical (rain)
	protected against ingress of solid bodies greater than 1mm (wire) protected against water splashed from all directions
	protected against limited ingress of dust (wet rooms/covered outdoor areas) protected against water splashed from all directions
	protected against ingress of dust protected against jets of water
	protected against ingress of dust protected against powerful jets of water or heavy seas
	protected against ingress of dust protected against immersion of water between 15cm - 1m for 30 minutes
	protected against ingress of dust protected against immersion of water under pressure for long periods

### IK RATING

	protected against 0.14 joules impact (equivalent to 0.25kg mass dropped from 56mm above the surface)
	protected against 0.2 joules impact (equivalent to 0.25kg mass dropped from 80mm above the surface)
	protected against 0.35 joules impact (equivalent to 0.25kg mass dropped from 140mm above the surface)
	protected against 0.5 joules impact (equivalent to 0.25kg mass dropped from 200mm above the surface)
	protected against 0.7 joules impact (equivalent to 0.25kg mass dropped from 280mm above the surface)
	protected against 1 joules impact (equivalent to 0.25kg mass dropped from 400mm above the surface)
	protected against 2 joules impact (equivalent to 0.5kg mass dropped from 400mm above the surface)
	protected against 5 joules impact (equivalent to 1.7kg mass dropped from 300mm above the surface)
	protected against 10 joules impact (equivalent to 5.0kg mass dropped from 200mm above the surface)
	protected against 20 joules impact (equivalent to 5.0kg mass dropped from 400mm above the surface)